

POWR-BLOKS™

Distribution/Splicer Blocks and Covers



Description

POWR-BLOKS™ power distribution blocks offer a safe, convenient way of splicing cables, providing a fixed junction tap-off point or splitting primary power into secondary circuits. Lx2xxx-DIN series offers integral DIN-Rail mount and an optional hinged safety cover.

Optional power distribution block covers provide protection against accidental shorting between poles caused by loose wires, tools, or other conductive material. They also protect personnel from accidentally contacting energized connectors. To order protective covers, match the number of poles for the block to the cover.

Hinged Plastic Covers

CATALOG/SYSTEM NUMBER	FOR USE WITH DISTRIBUTION/SPLICER BLOCK NO.	POLES
LCH132-1	0LCH1321Z LD2xxx-1DIN / LS2xxx-1DIN	1
LCH132-2	0LCH1322Z LD2xxx-2DIN / LS2xxx-2DIN	2
LCH132-3	0LCH1323Z LD2xxx-3DIN / LS2xxx-3DIN	3

Note: Optional hinged covers snap on to blocks.

Clear Plastic Covers

CATALOG/SYSTEM NUMBER	FOR USE WITH DISTRIBUTION/SPLICER BLOCK NO.	POLES
LPBC0-2	LPBC02 LD0xxx-2 / LS0xxx-2	2
LPBC0-3	LPBC03 LD0xxx-3 / LS0xxx-3	3
LPBC2-1	LPBC21 LD2xxx-1 / LS2xxx-1	1
LPBC2-2	LPBC22 LD2xxx-2 / LS2xxx-2	2
LPBC2-3	LPBC23 LD2xxx-3 / LS2xxx-3	3
LPBC3-1	LPBC31 LD3xxx-1 / LS3xxx-1	1
LPBC3-2	LPBC32 LD3xxx-2 / LS3xxx-2	2
LPBC3-3	LPBC33 LD3xxx-3 / LS3xxx-3	3
LPBC4-1	LPBC41 LD4xxx-1 / LS4xxx-1	1
LPBC4-2	LPBC42 LD4xxx-2 / LS4xxx-2	2
LPBC4-3	LPBC43 LD4xxx-3 / LS4xxx-3	3
LPBC5-1	LPBC51 LD5xxx-1 / LS5xxx-1	1
LPBC5-2	LPBC52 LD5xxx-2 / LS5xxx-2	2
LPBC5-3	LPBC53 LD5xxx-3 / LS5xxx-3	3

Note: For installation of optional clear plastic covers, use the screws provided with each cover.

Applications

Typical applications include heating, air conditioning and refrigeration systems, elevator systems, material handling equipment, control panels, motor controls, switchgear, and anywhere power needs to be distributed to more than one load.

Connectors

Box lug connectors are designed for use with a single, solid or class B or C stranded conductor. Use of more than one conductor per connector opening or use of extra-flexible, fine-stranded conductors, such as welding cable, voids the UL Listing and may cause overheating. Manufacturers of cable terminations can furnish crimp-on sleeves for fine stranded conductors which permit these conductors to be used with box lugs.

Ampere Ratings

The ampere rating per pole for power distribution blocks is based on the line ampacity of 75°C insulated conductors per NEC® Table 310.16. If 60°C insulated conductors are used, load must not exceed the ampacity of 60°C conductors. Use of conductors rated in excess of 75°C is permitted (for example 90°C), however, load must not exceed the ampacity of 75°C conductors.

Specifications

Voltage Rating:	600 V
Current Rating:	Based on NEC Table 310.16, using 75°C copper wire
Material:	Phenolic rated at 150°C and Thermoplastic rated at 125°C (LD1400 and LS1300 series only)
Connector:	Standard: Highly conductive aluminum, tin plated Copper: Highly conductive copper, tin plated
Flammability Rating:	UL94 V-0
Approvals:	UL Recognized (File No. E171395) CSA Certified (File No. LR700111)

Ordering Information

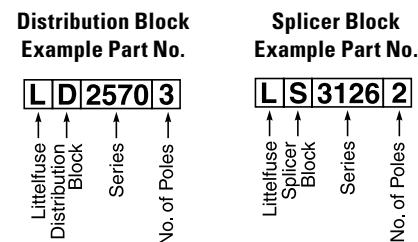

Note: Aluminum blocks can use copper or aluminum wire; copper blocks can only use copper wire.

Web Resources

For more information, visit: www.littelfuse.com/powr-bloks

DISTRIBUTION/SPLICER BLOCKS AND COVERS

Distribution Block Selection Guide

CONNECTOR CONFIGURATION			AMP RATING PER POLE	POLES	LINE		LOAD		OUTLINE DRAWING FIGURE	CATALOG/SYSTEM NUMBER	
MATERIAL	LINE	LOAD			WIRE RANGE	OPENINGS PER POLE	WIRE RANGE	OPENINGS PER POLE			
AL			115	1	#2 - #14	1	#10 - #18	4	2	LD1400-1	OLD14001Z
			115	2	#2 - #14	1	#10 - #18	4	2	LD1400-2	OLD14002Z
			115	3	#2 - #14	1	#10 - #18	4	2	LD1400-3	OLD14003Z
			115	4	#2 - #14	1	#10 - #18	4	2	LD1400-4	OLD14004Z
AL			175	2	20 - #14	1	#4 - #14	6	1	LD0401-2	OLD04012Z
			175	3	20 - #14	1	#4 - #14	6	1	LD0401-3	OLD04013Z
AL			175	2	20 - #14	1	#4 - #14	4	1	LD0402-2	OLD04022Z
			175	3	20 - #14	1	#4 - #14	4	1	LD0402-3	OLD04023Z
AL			310	2	350mcm - #6	1	#4 - #14	6	1	LD0404-2	OLD04042Z
			310	3	350mcm - #6	1	#4 - #14	6	1	LD0404-3	OLD04043Z
AL			175	1	20 - #14	1	#4 - #14	4	3	LD2570-1	OLD25701Z
			175	2	20 - #14	1	#4 - #14	4	3	LD2570-2	OLD25702Z
			175	3	20 - #14	1	#4 - #14	4	3	LD2570-3	OLD25703Z
CU			175	1	20 - #14	1	#4 - #14	4	3	LD2970-1	OLD29701Z
			175	2	20 - #14	1	#4 - #14	4	3	LD2970-2	OLD29702Z
			175	3	20 - #14	1	#4 - #14	4	3	LD2970-3	OLD29703Z
AL			335	1	400mcm - #6	1	#2 - #14	4	5	LD3552-1	OLD35521Z
			335	2	400mcm - #6	1	#2 - #14	4	5	LD3552-2	OLD35522Z
			335	3	400mcm - #6	1	#2 - #14	4	5	LD3552-3	OLD35523Z
AL			335	1	400mcm - #6	1	#2 - #14	6	5	LD3553-1	OLD35531Z
			335	2	400mcm - #6	1	#2 - #14	6	5	LD3553-2	OLD35532Z
			335	3	400mcm - #6	1	#2 - #14	6	5	LD3553-3	OLD35533Z
AL			350	1	20 - #14	2	#4 - #14	6	5	LD3555-1	OLD35551Z
			350	2	20 - #14	2	#4 - #14	6	5	LD3555-2	OLD35552Z
			350	3	20 - #14	2	#4 - #14	6	5	LD3555-3	OLD35553Z
CU			380	1	500mcm - #4	1	#2 - #14	6	5	LD3953-1	OLD39531Z
			380	2	500mcm - #4	1	#2 - #14	6	5	LD3953-2	OLD39532Z
			380	3	500mcm - #4	1	#2 - #14	6	5	LD3953-3	OLD39533Z
CU			350	1	20 - #14	2	#4 - #14	6	5	LD3955-1	OLD39551Z
			350	2	20 - #14	2	#4 - #14	6	5	LD3955-2	OLD39552Z
			350	3	20 - #14	2	#4 - #14	6	5	LD3955-3	OLD39553Z
AL			380	1	500mcm - #4	1	#2 - #14	6	6	LD4551-1	OLD45511Z
			380	2	500mcm - #4	1	#2 - #14	6	6	LD4551-2	OLD45512Z
			380	3	500mcm - #4	1	#2 - #14	6	6	LD4551-3	OLD45513Z
AL			335	1	400mcm - #6	1	#2 - #14	8	6	LD4560-1	OLD45601Z
			335	2	400mcm - #6	1	#2 - #14	8	6	LD4560-2	OLD45602Z
			335	3	400mcm - #6	1	#2 - #14	8	6	LD4560-3	OLD45603Z
AL			380	1	500mcm - #4	1	#2 - #14	12	7	LD5552-1	OLD55521Z
			380	2	500mcm - #4	1	#2 - #14	12	7	LD5552-2	OLD55522Z
			380	3	500mcm - #4	1	#2 - #14	12	7	LD5552-3	OLD55523Z
AL			380	1	500mcm - #4	1	20 - #14	6	7	LD5579-1	OLD55791Z
			380	2	500mcm - #4	1	20 - #14	6	7	LD5579-2	OLD55792Z
			380	3	500mcm - #4	1	20 - #14	6	7	LD5579-3	OLD55793Z
AL			760	1	500mcm - #4	2	20 - #14	8	7	LD5586-1	OLD55861Z
			760	2	500mcm - #4	2	20 - #14	8	7	LD5586-2	OLD55862Z
			760	3	500mcm - #4	2	20 - #14	8	7	LD5586-3	OLD55863Z
AL			665	1	500mcm - #4 350mcm - #6	1 1	20 - #14	4	7	LD5587-1	OLD55871Z
			665	2	500mcm - #4 350mcm - #6	1 1	20 - #14	4	7	LD5587-2	OLD55872Z
			665	3	500mcm - #4 350mcm - #6	1 1	20 - #14	4	7	LD5587-3	OLD55873Z

AL=Aluminum, CU=Copper

DISTRIBUTION/SPLICER BLOCKS AND COVERS

Distribution Block Selection Guide

CONNECTOR CONFIGURATION			AMP RATING PER POLE	POLES	LINE		LOAD		OUTLINE DRAWING FIGURE	CATALOG/SYSTEM NUMBER	
MATERIAL	LINE	LOAD			WIRE RANGE	OPENINGS PER POLE	WIRE RANGE	OPENINGS PER POLE			
AL			760	1	500mcm-#4	2	#4 - #14	12	7	LD5592-1	OLD55921Z
			760	2	500mcm-#4	2	#4 - #14	12	7	LD5592-2	OLD55922Z
			760	3	500mcm-#4	2	#4 - #14	12	7	LD5592-3	OLD55923Z
AL			380	1	500mcm-#4	1	#2 - #14	8	7	LD5594-1	OLD55941Z
			380	2	500mcm-#4	1	#2 - #14	8	7	LD5594-2	OLD55942Z
			380	3	500mcm-#4	1	#2 - #14	8	7	LD5594-3	OLD55943Z
CU			760	1	500mcm-#4	2	20 - #14	8	7	LD5986-1	OLD59861Z
			760	2	500mcm-#4	2	20 - #14	8	7	LD5986-2	OLD59862Z
			760	3	500mcm-#4	2	20 - #14	8	7	LD5986-3	OLD59863Z
CU			760	1	500mcm-#4	2	#2 - #14	12	7	LD5992-1	OLD59921Z
			760	2	500mcm-#4	2	#2 - #14	12	7	LD5992-2	OLD59922Z
			760	3	500mcm-#4	2	#2 - #14	12	7	LD5992-3	OLD59923Z
AL			175	1	20 - #14	1	#4 - #14	4	4	LD2570-1DIN	OLD25701ZXDIN
			175	2	20 - #14	1	#4 - #14	4	4	LD2570-2DIN	OLD25702ZXDIN
			175	3	20 - #14	1	#4 - #14	4	4	LD2570-3DIN	OLD25703ZXDIN
			175	Adder	20 - #14	1	#4 - #14	4	4	LD2570-ADIN	OLD2570AZXDIN
AL			175	1	20 - #14	1	#4 - #14	6	4	LD2580-1DIN	OLD25801ZXDIN
			175	2	20 - #14	1	#4 - #14	6	4	LD2580-2DIN	OLD25802ZXDIN
			175	3	20 - #14	1	#4 - #14	6	4	LD2580-3DIN	OLD25803ZXDIN
			175	Adder	20 - #14	1	#4 - #14	6	4	LD2580-ADIN	OLD2580AZXDIN
CU			175	1	20 - #14	1	#4 - #14	4	4	LD2970-1DIN	OLD29701ZXDIN
			175	2	20 - #14	1	#4 - #14	4	4	LD2970-2DIN	OLD29702ZXDIN
			175	3	20 - #14	1	#4 - #14	4	4	LD2970-3DIN	OLD29703ZXDIN
			175	Adder	20 - #14	1	#4 - #14	4	4	LD2970-ADIN	OLD2970AZXDIN

AL=Aluminum, CU=Copper





























Hinged Plastic Covers



Clear Plastic Covers

DISTRIBUTION/SPLICER BLOCKS AND COVERS

Splicer Block Selection Guide

CONNECTOR CONFIGURATION			AMP RATING PER POLE	POLES	LINE		LOAD		OUTLINE DRAWING FIGURE	CATALOG/SYSTEM NUMBER	
MATERIAL	LINE	LOAD			WIRE RANGE	OPENINGS PER POLE	WIRE RANGE	OPENINGS PER POLE			
AL			310	2	350mcm-#6	1	350mcm-#6	1	1	LS0303-2	OLS0303Z2
			310	3	350mcm-#6	1	350mcm-#6	1	1	LS0303-3	OLS0303Z3
AL			115	1	#2 - #14	1	#2 - #14	1	2	LS1300-1	OLS13001Z
			115	2	#2 - #14	1	#2 - #14	1	2	LS1300-2	OLS13002Z
			115	3	#2 - #14	1	#2 - #14	1	2	LS1300-3	OLS13003Z
			115	4	#2 - #14	1	#2 - #14	1	2	LS1300-4	OLS13004Z
CU			150	1	1/0 - #18	1	1/0 - #18	1	3	LS2121-1	OLS21211Z
			150	2	1/0 - #18	1	1/0 - #18	1	3	LS2121-2	OLS21212Z
			150	3	1/0 - #18	1	1/0 - #18	1	3	LS2121-3	OLS21213Z
AL			115	1	#2 - #14	1	#2 - #14	1	3	LS2552-1	OLS25521Z
			115	2	#2 - #14	1	#2 - #14	1	3	LS2552-2	OLS25522Z
			115	3	#2 - #14	1	#2 - #14	1	3	LS2552-3	OLS25523Z
AL			175	1	2/0 - #14	1	2/0 - #14	1	3	LS2572-1	OLS25721Z
			175	2	2/0 - #14	1	2/0 - #14	1	3	LS2572-2	OLS25722Z
			175	3	2/0 - #14	1	2/0 - #14	1	3	LS2572-3	OLS25723Z
AL			255	1	250mcm-#6	1	250mcm-#6	1	5	LS3123-1	OLS31231Z
			255	2	250mcm-#6	1	250mcm-#6	1	5	LS3123-2	OLS31232Z
			255	3	250mcm-#6	1	250mcm-#6	1	5	LS3123-3	OLS31233Z
CU			255	1	250mcm-#6	1	250mcm-#6	1	5	LS3124-1	OLS31241Z
			255	2	250mcm-#6	1	250mcm-#6	1	5	LS3124-2	OLS31242Z
			255	3	250mcm-#6	1	250mcm-#6	1	5	LS3124-3	OLS31243Z
AL			310	1	350mcm-#6	1	350mcm-#6	1	5	LS3126-1	OLS31261Z
			310	2	350mcm-#6	1	350mcm-#6	1	5	LS3126-2	OLS31262Z
			310	3	350mcm-#6	1	350mcm-#6	1	5	LS3126-3	OLS31263Z
AL			420	1	600mcm-#4	1	600mcm-#4	1	6	LS4557-1	OLS45571Z
			420	2	600mcm-#4	1	600mcm-#4	1	6	LS4557-2	OLS45572Z
			420	3	600mcm-#4	1	600mcm-#4	1	6	LS4557-3	OLS45573Z
AL			620	1	350mcm-#4	2	350mcm-#4	2	7	LS5129-1	OLS51291Z
			620	2	350mcm-#4	2	350mcm-#4	2	7	LS5129-2	OLS51292Z
			620	3	350mcm-#4	2	350mcm-#4	2	7	LS5129-3	OLS51293Z
AL			760	1	500mcm-#4	2	500mcm-#4	2	7	LS5301-1	OLS53011Z
			760	2	500mcm-#4	2	500mcm-#4	2	7	LS5301-2	OLS53012Z
			760	3	500mcm-#4	2	500mcm-#4	2	7	LS5301-3	OLS53013Z
AL			175	1	2/0 - #14	1	2/0 - #14	1	4	LS2572-1DIN	OLS25721ZXDIN
			175	2	2/0 - #14	1	2/0 - #14	1	4	LS2572-2DIN	OLS25722ZXDIN
			175	3	2/0 - #14	1	2/0 - #14	1	4	LS2572-3DIN	OLS25723ZXDIN
			175	Adder	2/0 - #14	1	2/0 - #14	1	4	LS2572-ADIN	OLS2572AZXDIN
CU			175	1	2/0 - #14	1	2/0 - #14	1	4	LS2972-1DIN	OLS29721ZXDIN
			175	2	2/0 - #14	1	2/0 - #14	1	4	LS2972-2DIN	OLS29722ZXDIN
			175	3	2/0 - #14	1	2/0 - #14	1	4	LS2972-3DIN	OLS29723ZXDIN
			175	Adder	2/0 - #14	1	2/0 - #14	1	4	LS2972-ADIN	OLS2972AZXDIN

AL=Aluminum, CU=Copper

DISTRIBUTION/SPLICER BLOCKS AND COVERS DIMENSIONS

Outline Drawing Figures

Dimensions in inches (mm)

LX0XXX
Figure 1

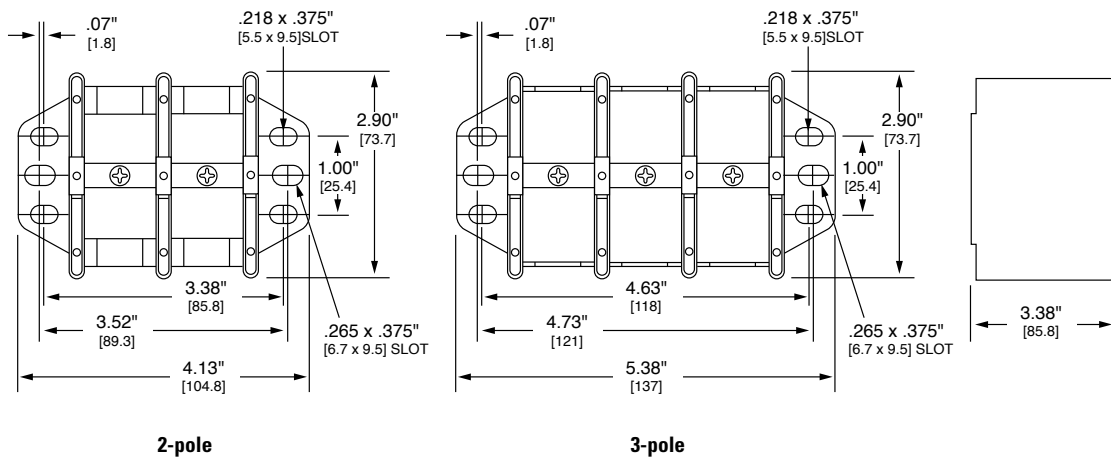

LX1XXX
Figure 2

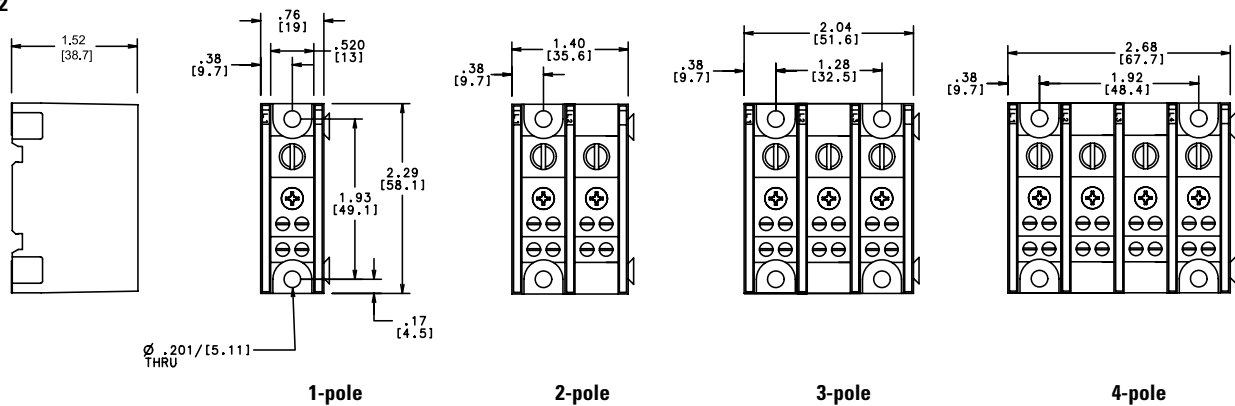

LX2XXX
Figure 3

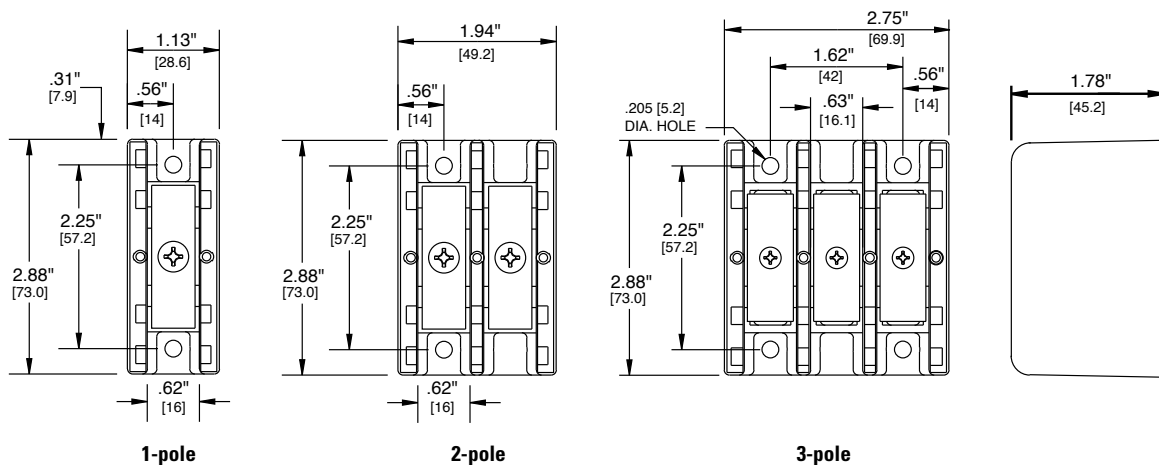

Dimensions available at www.littelfuse.com/powr-bloks

DISTRIBUTION/SPLICER BLOCKS AND COVERS DIMENSIONS

Outline Drawing Figures

Dimensions in inches (mm)

LX2XXX-XDIN
Figure 4

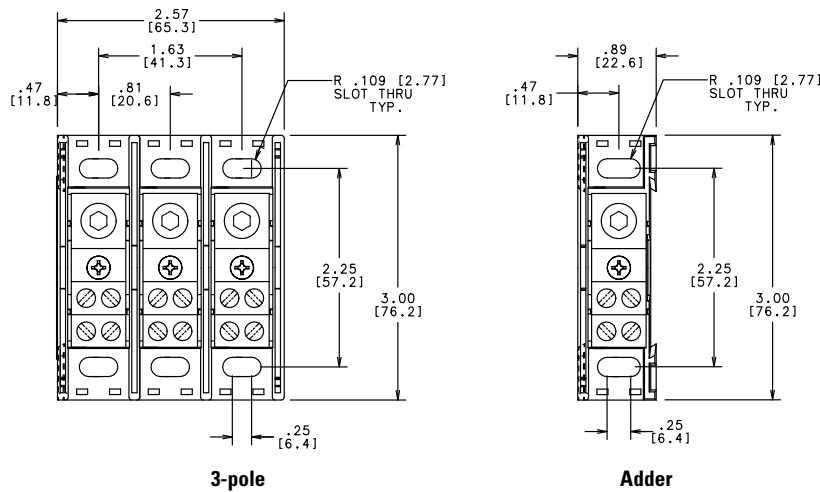
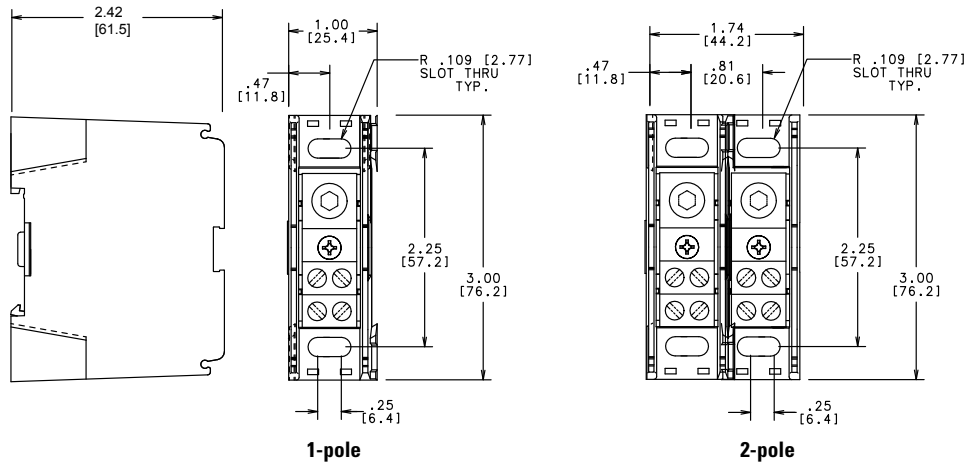

LX3XXX
Figure 5

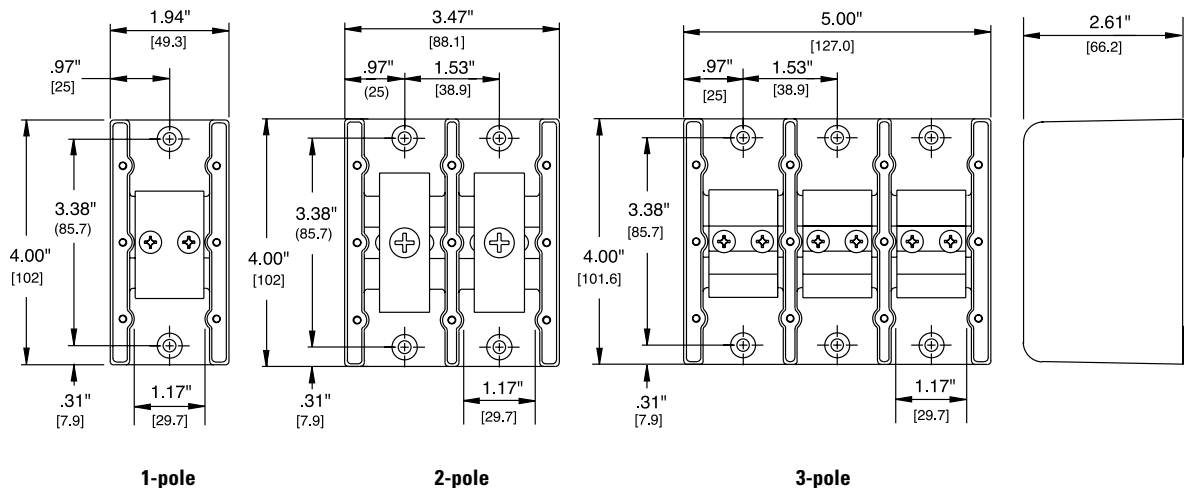

Dimensions available at www.littelfuse.com/powr-bloks

DISTRIBUTION/SPLICER BLOCKS AND COVERS DIMENSIONS

Outline Drawing Figures

Dimensions in inches (mm)

LX4XXX
Figure 6

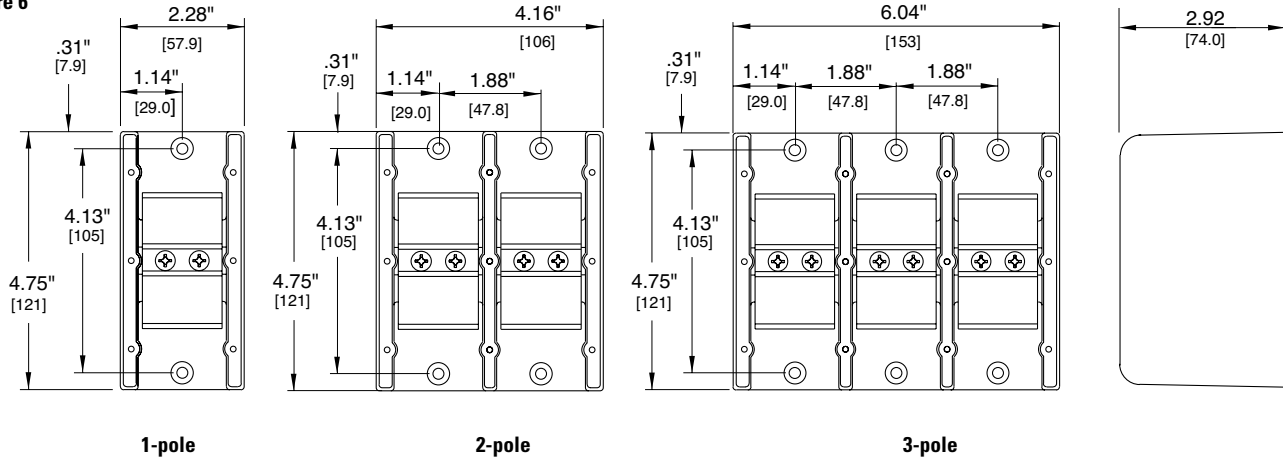

LX5XXX
Figure 7

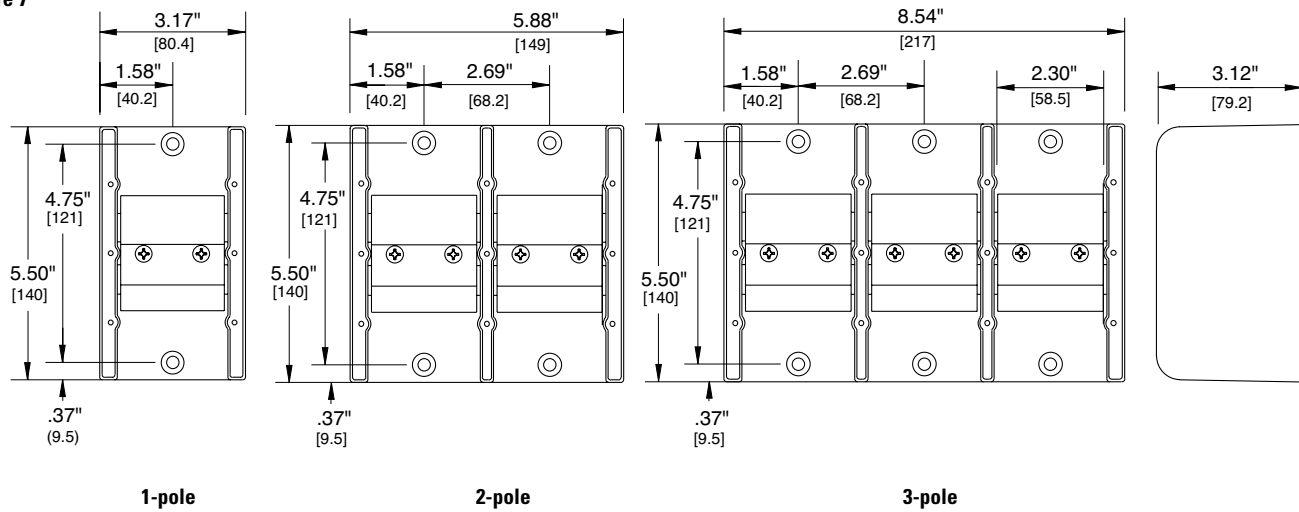

Dimensions available at www.littelfuse.com/powr-bloks